

A-A (1:20)

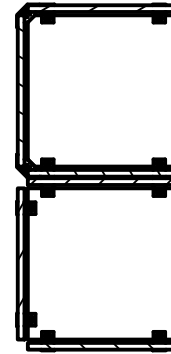

C (1:10)

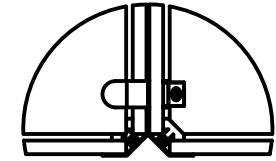

D (1:10)

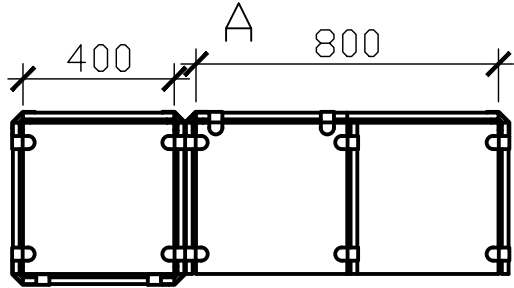
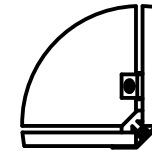

B-B (1:20)

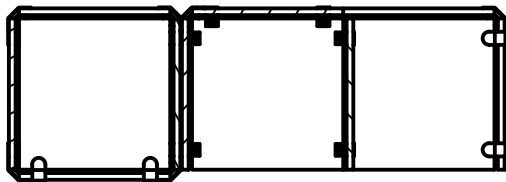

EE-E (1:5)

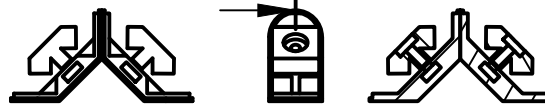

F-F (1:5)

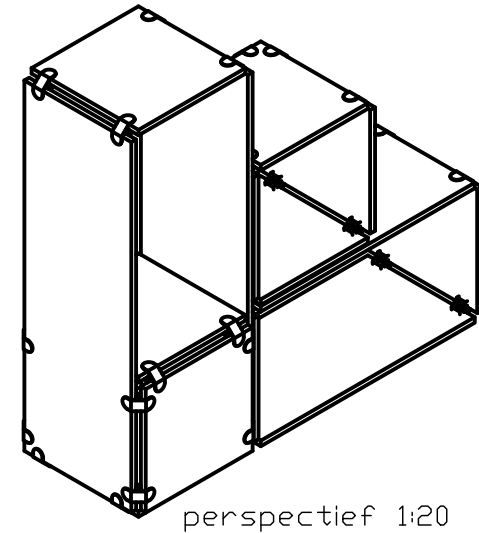
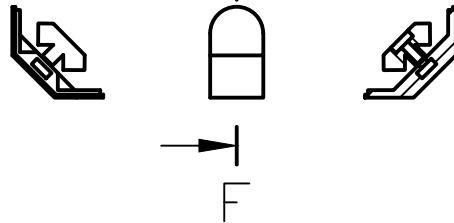

Schaal: 1:20	opbergkast	Klas: STHP	03.05.2023
		Getekend: Quick Sense	
		Gezien:	
	VTI ROESELARE	Ident. nr: 3	